

*Distributed by*

**P/N : 388037055**  
**PRINTED IN KOREA**

INSTRUCTION MANUAL  
**FULL HD MEGA PIXEL  
ZOOM CAMERA**

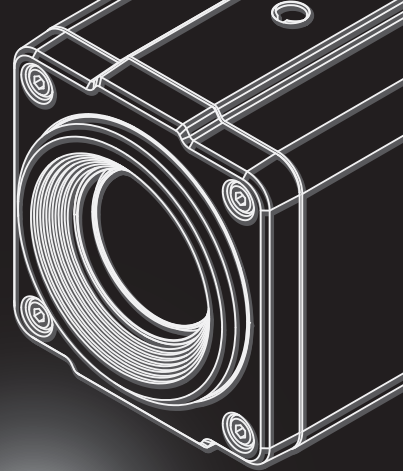
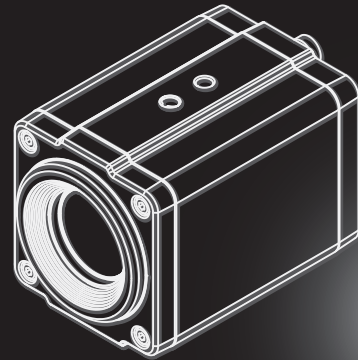

- Before attempting to connect or operate this product, please read these instructions carefully and save this manual for future use.
- The design and specifications are subject to be changed without prior notice to improve product's quality.



**CAUTION**  
RISK OF ELECTRIC SHOCK  
DO NOT OPEN



**CAUTION** : TO REDUCE THE RISK OF ELECTRIC SHOCK  
DO NOT REMOVE COVER (OR BACK)  
NO USER SERVICEABLE PARTS INSIDE  
REFER SERVICING TO QUALIFIED  
SERVICE PERSONNEL  
REFER SERVICING TO QUALIFIED SERVICE PERSONNEL.



The lightning flash with an arrowhead symbol within an equilateral triangle is intended to alert the user to the presence of uninsulated dangerous voltage within the product's enclosure that may be of sufficient magnitude to constitute a risk of electric shock to persons.



The exclamation point within an equilateral triangle is intended to alert the user to the presence of important operating and maintenance (servicing) instructions in the literature accompanying the product.

**FCC WARNING** - This equipment may generate or use radio frequency energy. Changes or modifications to this equipment may cause harmful interference unless the modifications are expressly approved in the instruction

manual. The user could lose the authority to operate this equipment if an unauthorized change or modification is made.

**REGULATORY INFORMATION : FCC Part 15**

This equipment has been tested and found to comply with the limits for a Class A digital device, pursuant to Part 15 of the FCC Rules. These limits are designed to provide reasonable protection against harmful interference when the equipment is operated in a commercial environment. This equipment generates, uses, and can radiate radio frequency energy and, if not installed and used in accordance with the instruction manual, may cause harmful interference to radio communications. Operation of this equipment in a residential area is likely to cause harmful interference in which case the user will be required to correct the interference at his own expense.

- A suitable conduit entries, knock-outs or glands shall be provided in the cable entries of this product in the end use.

- Holes in metal, through which insulated wires pass, shall have smooth well rounded surfaces or shall be provided with brushings.

**WARNING** - Do not install this equipment in a confined space such as a bookcase or similar unit.

**WARNING** - Wiring methods shall be in accordance with the National Electric Code, ANSI/NFPA 70.

**WARNING** - This is a class A product. In a domestic environment this product may cause radio interference in which case the user may be required to take adequate measures.

**WARNING** - To reduce a risk of fire or electric shock, do not expose this product to rain or moisture.

**CAUTION** - This installation should be made by a qualified service personnel and should conform to all local codes.

**CAUTION** - To avoid electrocution, do not open the cabinet. Refer servicing to qualified personnel only.

**CAUTION** - The apparatus should not be exposed to water (dripping or splashing) and no objects filled with liquids, such as vases, should be placed on the apparatus.



**Disposal of your old appliance**

1. When this crossed-out wheeled bin symbol is attached to a product it means the product is covered by the European Directive 2002/96/EC
2. All electrical and electronic products should be disposed of separately from the municipal waste stream via designated collection facilities appointed by the government or the local authorities
3. The correct disposal of your old appliance will help prevent potential negative consequences for the environment and human health
4. For more detailed information about disposal of your old appliance, please contact your city office, waste disposal service or the shop where you purchased the product.

To disconnect power from the mains, pull out the main cord plug. When installing the product, ensure that the plug is easily accessible.

## IMPORTANT SAFETY INSTRUCTIONS

- 1. Read these instructions** - All these safety and operating instructions should be read before the product is operated.
- 2. Keep these instructions** - The safety, operating and user instructions should be retained for future reference.
- 3. Heed all warnings** - All warnings on the product and in the operating instructions should be adhered to.
- 4. Follow all instructions** - All operating and user instructions should be followed.
- 5. Do not use this apparatus near water** - For example : near a bath tub, wash bowl, kitchen sink, laundry tub, in a wet basement, near a swimming pool, etc.
- 6. Clean only with dry cloth** - Unplug this product from the wall outlet before cleaning. Do not use liquid cleaners.
- 7. Do not block any ventilation openings. Install in accordance with the manufacturer's instructions.** - Slots and openings in the cabinet are provided for ventilation, to ensure reliable operation of the product, and to protect it from overheating. The openings should never be blocked by placing the product on a bed, sofa, rug or other similar surface. This product should not be placed in a built-in installation such as a bookcase or rack unless proper ventilation is provided and the manufacturer's instructions have been adhered to.
- 8. Do not install near any heat sources such as radiators, heat registers, stoves, or other apparatus (including amplifiers) that produce heat.**

## IMPORTANT SAFETY INSTRUCTIONS

- 9. Protect the power cord from being walked on or pinched particularly at plugs, convenience receptacles, and the point where they exit from the apparatus.**
- 10. Only use attachments/accessories specified by the manufacturer.**
- 11. Unplug this apparatus during lightning storms or when unused for long periods of time.**
- 12. Refer all servicing to qualified service personnel.** Servicing is required when the apparatus has been damaged in any way, such as power supply cord or plug is damaged, liquid has been spilled or objects have fallen into the apparatus, the apparatus has been exposed to rain or moisture, does not operate normally, or has been dropped.



FEATURES.....	7P	SPECIAL FUNCTION .....	26P
PACKAGE COMPONENTS .....	8P	DISPLAY .....	28P
SYSTEM CONFIGURATION.....	9P	SPECIFICATION .....	30P
PART NAMES AND FUNCTIONS .....	10P	DRAWING .....	33P
CONNECTIONS .....	12P	TROUBLESHOOTING .....	34P
EXTERNAL DEVICE CONNECTIONS.....	13P		
VIDEO OUT .....	14P		
MENU OPERATION .....	15P		
MAIN MENU .....	16P		
FOCUS .....	17P		
EXPOSURE .....	18P		
WHITE BALANCE .....	21P		
IMAGE .....	22P		
INTELLIGENCE .....	24P		

## Features

- 1/3" Panasonic CMOS sensor
- x10 Optical Zoom
- Full HD Resolution
- Day & Night(ICR)
- Wide Dynamic Range
- Digital Noise Reduction(2D+3D)
- Privacy Mask Function
- On Screen Display
- Intelligent Motion Detection
- Multi Protocol

# PACKAGE COMPONENTS

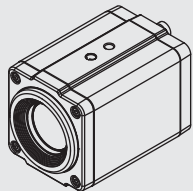

CAMERA



DC 12V CABLE



MANUAL

## [Optional Remote Controller]

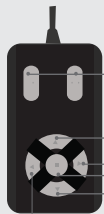

Not used

Tele/ Up

Far / Right

Menu/ Set

Wide / Down

Near / Left

# SYSTEM CONFIGURATION

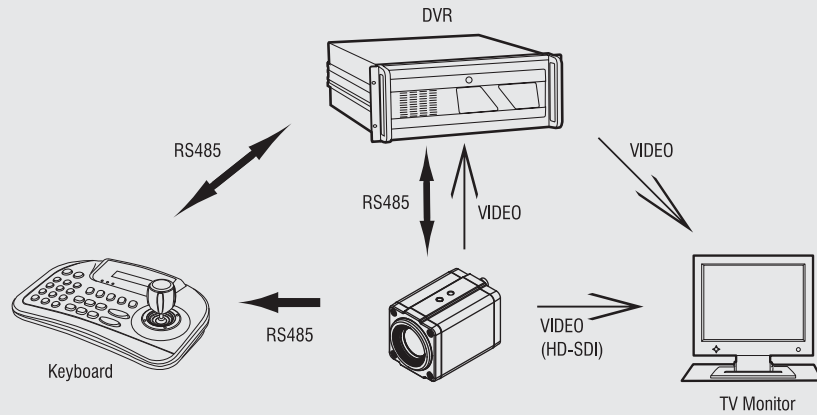

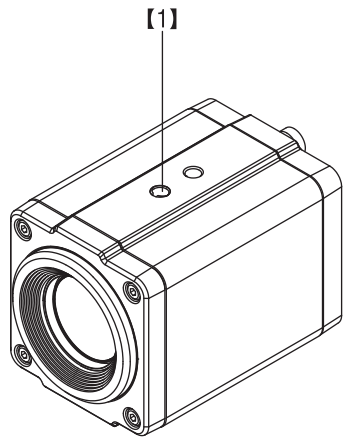

- 【1】 Camera installation bracket**  
The bracket can be fixed at the top or bottom of the camera.

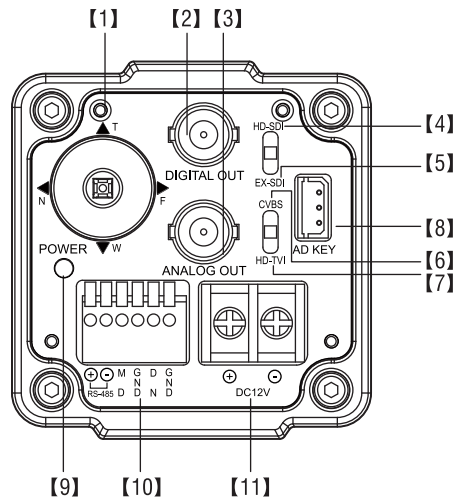

- 【1】 OSD / Zoom / Focus control
- 【2】 DIGITAL Out
- 【3】 ANALOG Out
- 【4】 HD-SDI
- 【5】 EX-SDI
- 【6】 CVBS
- 【7】 HD-TVI
- 【8】 AD Key
- 1: GND
- 2: AD-key
- 3: GND
- 【9】 Power LED
- 【10】 Control Terminal
- 1: RS-485 (+)
- 2: RS-485 (-)
- 3: Motion Detection Out
- 4: Ground
- 5: Day&Night Input (Low : Night, High : Day)
- 6: Ground
- 【11】 Power : DC12V

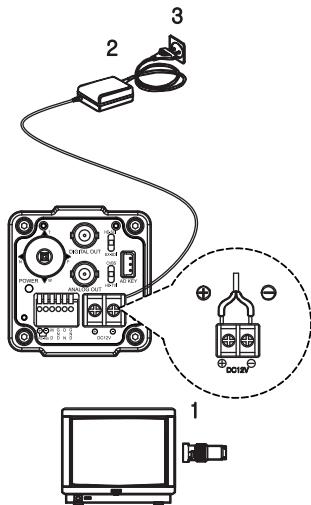

## Basic connection

The peripheral devices (DVR, monitor, lens, etc), DC adaptor and cables are not supplied.

### 1. Connecting the monitor.

Make the video signal connection between the camera and the monitor or time lapse monitor or DVR.

### 2. Use a commercially available DC12V adaptor.

Connect an DC 12V power source to the DC 12V input terminal on the back of the camera.

### 3. Insert the plug of this power cord into a wall outlet.

The POWER indicator will light. Adjust the picture on the monitor using the Brightness and Contrast controls etc.

To monitor's Video Input  
or Camera Input

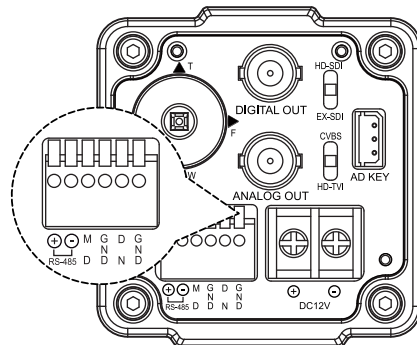

## RS-485 COMMUNICATION

Connect to an external controller of RS-485 format.

## Motion Detection Out

When the motion detection function is working, DC3.3V is outputted to OUT pin and GND pin.

## Day & Night input

Day/Night mode of the camera can be switched by signal from an external device. To use this function, <DAY&NIGHT> setting of the camera should be set to the <EXT>.

**Note :** Use a relay unit if the voltage or current of the connected device exceeds the ratings.

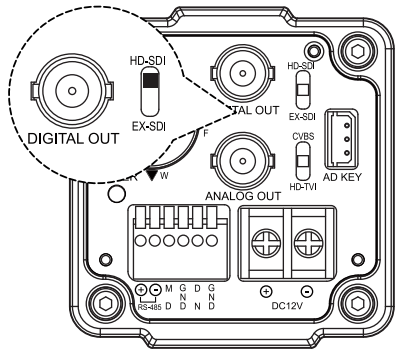

## DIGITAL OUT

Select HD-SDI and EX-SDI video out by switch setting.

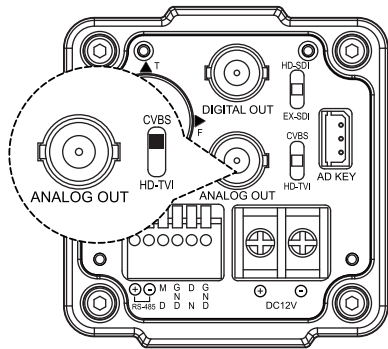

## ANALOG OUT

Select CVBS and TVI video out by switch setting.

This camera utilizes an on-screen user MENU. To set items on the menu, use the following buttons on the side panel.

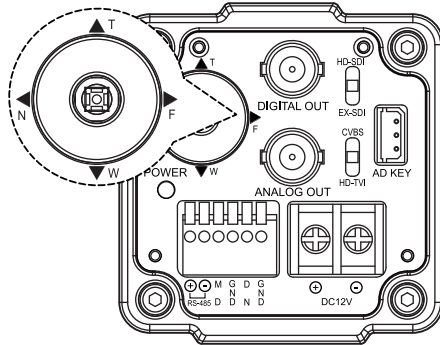

▲ <sup>T</sup> Tele(Up) button : Zoom in, Tele (Moves the cursor upwards. Use this button to select an item or adjust the parameters.)

▼ <sup>W</sup> Wide(Down) button : Zoom out, Wide (Moves the cursor downwards. Use this button to select an item or adjust the parameters.)

▶ <sup>F</sup> Far(Right) button : Adjust focus in Manual Mode (Moves the cursor to the right. Use this button to select or adjust the parameters of the selected item. The parameter changes each time this button is pressed.)

◀ <sup>N</sup> Near(Left) button : Adjust focus in Manual Mode (Moves the cursor to the left. Use this button to select or adjust the parameters of the selected item. The parameter changes each time this button is pressed.)

Ⓢ Set button : Executes selections and displays a submenu for an item with the  mark.



Camera menu is subject to be changed without prior notice to upgrade and quality increase and we may use slip sheet for the change.  
Please check the camera version and the slip sheet if the camera menu and this manual menu is not matched.

## MAIN MENU



Functions can be setup using “Menu Key Command” of Visca protocol.

The menu consists of the “Main Menu” and “Sub Menu”. The main menu is displayed where 7 camera functions can be selected.

To the push of each main menu selection, the sub-menu is displayed

If you want save the menu, select [SAVE]  
If you want not save the menu, select [EXIT]  
(After select , Power off → on)  
If you want default the menu, select [DFLT]

## FOCUS

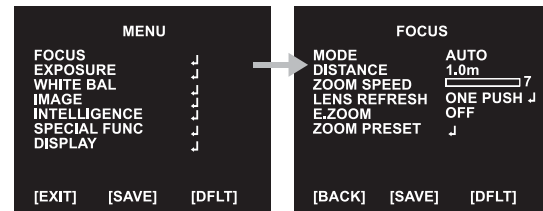

- ◆ MODE : Select auto focus mode
  - ▶ AUTO, ONE PUSH, MANUAL
- ◆ DISTANCE : Select minimum distance in focus between camera and object.
  - ▶ 0.1 / 1.0 / 3.0 / 5.0 / 10.0 m
- ◆ ZOOM SPEED : Select Zoom Speed ▶ 0 (Slow) ~ 7 (Fast)
- ◆ LENS REFRESH : Lens origin calibrated automatically.
  - ▶ ONE PUSH, J / ON (1 day ~ 10 days)
- ◆ E.ZOOM : Select maximum digital zoom magnification.
  - ▶ OFF / ON (max x2 ~ x19, x21, x23, x25, x28, x32)
- ◆ ZOOM PRESET : Select zoom preset
  - ▶ PRESET # : Select Zoom preset number (1 ~ 5) ▶ MODE : OFF / ON, J
  - ▷ ON, J : Adjust the Zoom Position

## EXPOSURE

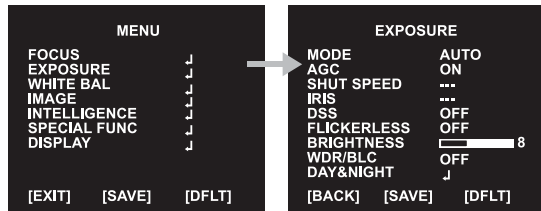

- ◆ **MODE** : Select Exposure Mode
  - ▶ AUTO / IRIS.P / SHUT.P / MANUAL
- ◆ **AGC** : Select Auto Gain Control
  - ▶ OFF / ON (AUTO, SHUT.P or IRIS.P Mode)
  - ▶ 0 ~ 10 (MANUAL Mode)
- ◆ **SHUT SPEED** : Can be set in SHUT.P or MANUAL mode
  - \* 60 / 50 fps mode ▶ x8, x4, x2, 1/60(50), 1/120(100), 1/250, 1/700, 1/1000, 1/1600, 1/2500, 1/5000, 1/7000, 1/10000, 1/30000 sec
  - \* 30 / 25 fps mode ▶ x4, x2, 1/30(25), 1/60(50), 1/120(100), 1/250, 1/700, 1/1000, 1/1600, 1/2500, 1/5000, 1/7000, 1/10000, 1/30000 sec
- ◆ **IRIS** : Iris level can be set in IRIS.P or MANUAL mode
  - ▶ 0 ~ 20

- ◆ **DSS** : Select maximum DSS (Digital Slow Shutter)
  - \* 60 / 50 fps mode ▶ OFF / x2, x4, x8
  - \* 30 / 25 fps mode ▶ OFF / x2, x4
- ◆ **FLICKERLESS** : Select Flicker less mode
  - ▶ OFF / ON (remove screen flicker)
- ◆ **BRIGHTNESS** : Adjust brightness level
  - ▶ 0(dark) ~ 20(bright) steps
- ◆ **WDR/BLC** : Select WDR(Wide Dynamic Range) or BLC(Back Light Compensation)
  - ▶ WDR, ↵
    - ▷ WDR\_WGT : Adjust WDR level.
      - ▶ LOW, MID-LOW, MIDDLE, MID-HIGH, HIGH
    - ※ WDR doesn't work in Manual Exposure Mode and Shutter Priority Mode.
    - ※ When WDR on, CVBS output is disabled.
  - ▶ BLC, ↵
    - ▷ POSITION : Adjust the window position
    - ▷ SIZE : Adjust the window size
    - ※ Can't use WDR and BLC at the same time.
      - (When WDR On, BLC is Off. And when BLC is On, WDR is Off)
    - ※ BLC doesn't work in Manual Exposure Mode.

## ◆ DAY&amp;NIGHT : Select Day&amp;Night

▶ MODE : AUTO / EXT-IN / DAY / NIGHT

## ▶ AUTO

▷ DELAY : 0 ~ 255 sec

▷ THRS : Day↔Night switching level in Auto Mode.

Switching in lower lux with higher threshold level.(0 ~ 28)

▷ GAP : LOW, MID-LOW, MIDDLE, MID-HIGH, HIGH

Margin between Day →Night switching level and Night →Day switching level.

▷ IR DETECTION : Setting IR Detection mode. (ON / OFF)

▷ IR DET LEVEL : Setting IR Detection level.(LOW, MID-LOW, MIDDLE, MID-HIGH, HIGH)

▷ BURST : OFF / ON

## ▶ EXT-IN

▷ DELAY : 0 ~ 255 sec

▷ BURST : OFF / ON

▷ POLARITY : External Input polarity (ACTIVE LOW / ACTIVE HIGH)

## ▶ NIGHT

▷ BURST : OFF / ON

## WHITE BALANCE

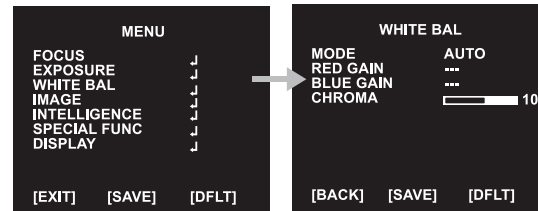

## ◆ AWB : Select WHITE BALANCE mode

▶ AUTO / ONE PUSH / MANUAL / INDOOR / OUTDOOR

▷ AUTO : Automatically adjusts color according to the available lighting.

▷ ONE PUSH : It is a fixed white balance mode that may be automatically readjusted only by pressing ONE PUSH

▷ MANUAL:↵ : Color can be corrected when the user increases or decreases "RED GAIN" or "BLUE GAIN".

▷ INDOOR : Set color temperature to be Indoor light (3700°K)

▷ OUTDOOR : Set color temperature to be Outdoor light (5100°K)

◆ RED GAIN : Adjust R gain value ▶ 0 ~ 20 steps

◆ BLUE GAIN : Adjust B gain value ▶ 0 ~ 20 steps

◆ CHROMA : Adjust CHROMA gain value ▶ 0 ~ 20 steps

## IMAGE

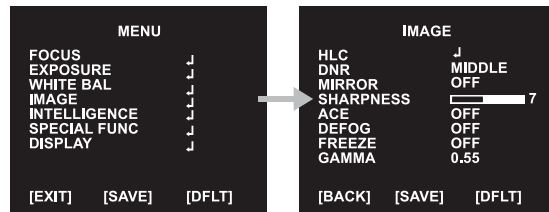

- ◆ HLC : Select High Light Compensation.
  - When extremely bright light is projected to the camera masking is used on the portion to prevent partial saturation on the monitor.
    - ▷ MODE : OFF / ON / NIGHT
    - ▷ LEVEL : 0 ~ 20 steps
    - ▷ COLOR : 0 ~ 13 steps
- ◆ DNR : Select Digital Noise Reduction
  - ▶ AUTO / OFF / LOW / MIDDLE / HIGH
- ◆ MIRROR : Select a flip mode
  - ▶ OFF / H / V / H&V
    - ▷ H : You can flip the picture horizontally on the screen
    - ▷ V : You can flip the picture vertically on the screen
    - ▷ H&V : You can flip the picture horizontally & vertically on the screen

## IMAGE

- ◆ SHARPNESS : Adjust sharpness level
  - ▶ 0 ~ 10 steps
- ◆ ACE : Select Digital WDR (Wide Dynamic Range)
  - ▶ OFF / LOW / MIDDLE / HIGH
- ◆ DEFOG : Carry out defog function
  - ▶ OFF / ON ↵
    - ▷ MODE : AUTO / MANUAL
    - ▷ LEVEL : LOW / MIDDLE / HIGH
- ※ Can't use DEFOG and ACE at the same time (When DEFOG is On, ACE is Off)
- ◆ Freeze : Select real or still mode
  - ▶ OFF / ON
- ◆ GAMMA : Select GAMMA
  - ▶ 0.45 / 0.55 / 0.65 / 0.75

## INTELLIGENCE

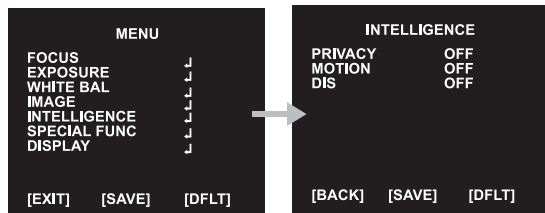

◆ PRIVACY : Hide an area you want to hide on the screen

- ▶ OFF / ON,↵
- ▷ MASK# : Select mask area number (1 ~ 24)
- ▷ MODE : Mask enable or disable (OFF / ON)
- ▷ POSITION : Adjust the mask position
- ▷ SIZE : Adjust the mask size
- ▷ COLOR : Select mask color (0 ~ 13)
- ▷ TRANS : Select mask transparency level (0 ~ 4)

◆ MOTION : When there is movement of the subject in the screen, there will be a motion detection

- ▶ OFF / ON,↵
  - ▷ AREA# : Setting 3 areas(1~3) of motion detection
  - ▷ MODE : OFF / ON (Limit and define areas of motion detection)
  - ▷ SENSITIVITY : Adjust sensitivity of MD (0 ~ 20 steps)  
More sensitive to setting to low step with sensitivity
  - ▷ POSITION : Adjust the Area position
  - ▷ SIZE : Adjust the Area size
  - ▷ INTERVAL : Select the alarm interval time (0 ~ 255sec)
  - ▷ DWELL TIME : Select the duration time about changing MD mode (0 ~ 255sec)
  - ▷ ZOOM PRESET : Select Motion Zoom Preset Mode and Position (OFF / ON,↵)
- ◆ DIS : Select Digital Image Stabilizer mode
  - ▶ OFF / ON,↵
    - ▷ RANGE : Setting the image compensation range. (10%, 20%, 30%)
    - ▷ FILTER : Setting the sensitivity to hold DIS function in worst case.(LOW, MIDDLE, HIGH)
    - ▷ AUTO C : Setting Auto Centering mode (OFF, HALF, FULL)

## SPECIAL FUNC

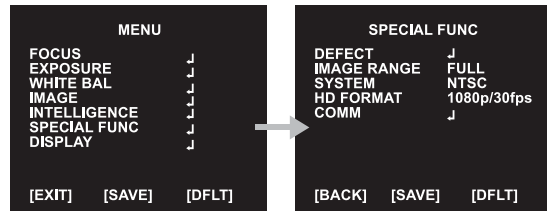

- ◆ DEFECT DET : Compensates for bad pixels that may occur.  
Occurs when the whole screen is in full black or if there is bad pixelation and it changes the THRS values until the screen is fixed.
- ※ When you use this function, you have to block the lens for blocking lights into the lens.
- ◆ IMAGE RANGE : Select image bit range. (Full : 100%, Compressed : 75%)
  - ▶ FULL, COMP, USER,┘
  - ▷ LEVEL : Select user mode level (0 ~ 32)
- ◆ SYSTEM : Select NTSC(30/60fps) or PAL(25/50fps).
- ◆ HD FORMAT : Select Digital output(1080p/30(25)fps, 1080p/60(50)fps, 720p/30(25)fps, 720p/60(50)fps)

- ◆ COMM : Set up the camera ID, baud rate, protocol
  - ▷ ID : Select the camera ID
    - ▶ 1 ~ 255
  - ▷ BAUD RATE : Select serial communication speed
    - ▶ 2400 / 4800 / 9600 / 19200 / 38400 / 57600 / 115200bps
  - ▷ PROTOCOL : Select operating protocol
    - ▶ VISCA / PELCO-D / PELCO-P / UPDATE

## DISPLAY

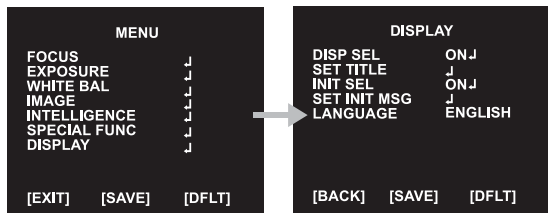

- ◆ DISP SEL : Select display item.
  - ▶ OFF / ON,↵
  - ▷ ID : OFF / ON
  - ▷ TITLE : OFF / ON
  - ▷ ZOOM RATIO : OFF / ON
  - ▷ SYSTEM MSG : OFF / ON (MD Alarm)
- ◆ SET TITLE : Select camera title menu (Text edit– max 40 characters)
- ◆ INIT SEL : Select display initial message.
  - ▶ OFF / ON,↵
  - ▷ ID : OFF / ON ▷ BAUDRATE : OFF / ON
  - ▷ PROTOCOL : OFF / ON ▷ VERSION : OFF / ON
  - ▷ INIT MSG : OFF / ON

- ◆ SET INIT MSG : modify initial message. (Text edit – max 40 characters)
- ◆ LANGUAGE : Select language.
  - ▶ English / Simplified Chinese / Traditional Chinese / Japanese

※ Character Table of Text edit Mode

```

A B C D E F G H I J K L M N O P Q R S T
U V W X Y Z a b c d e f g h i j k l m n
o p q r s t u v w x y z , . ( ) { } [ ]
0 1 2 3 4 5 6 7 8 9 * + - / = ~ ! ? " '
    
```

# SPECIFICATION

Image Sensor	1/3" Panasonic CMOS Sensor			
Total Pixels	1,956(H) x 1,266(V), 2.48M Pixels			
Active pixels	1,944(H) x 1,092(V), 2.12M Pixels			
Scanning system	Progressive Scan			
Sync. System	Internal			
Resolution	Digital : 1080p/60(50)fps, 1080p/30(25)fps, 720p/60(50)fps, 720p/30(25)fps			
	Analog : 700TVL			
Min. illumination	Color : 0.5 lux , BW : 0.1lux			
	Color DSS : 0.002 lux , BW DSS : 0.001 lux			
Video Output	HD : HD-TVI / HD-SDI / EX-SDI			
	Analog SD : VBS(without WDR)			
S/N Ratio	more than 50dB (AGC off)			
Lens type	x10 Day & Night Zoom Lens			
Zoom Ratio	Optical x10, Digital x32 Zoom			
Focal Length	f = 5.1mm ~ 51mm			
Aperture Ratio	F1.6 (wide) ~ F1.8 (tele)			
Angle of View (D, H, V)	Wide	68°	54°	31°
	Tele	6.7°	4.9°	4.0°
Focus	Mode / Distance / Zoom Speed / Lens Refresh / E.Zoom			
Mode	Auto / One Push / Manual			
Distance	0.1 / 1.0 / 3.0 / 5.0 / 10.0 m			
Zoom Speed	0(Slow) ~ 7(Fast)			
Lens Refresh	One Push / 1 ~ 10Day			
E.Zoom	Off / MAX x2 ~ x32			

# SPECIFICATION

Zoom Preset	5 preset
Exposure	Mode / AGC / Shut Speed / Iris / DSS / Flickerless / Brightness / WDR/BLC / D&N
Mode	Auto / Iris. Priority / Shut. Priority / Manual
Gain Control(AGC)	Off / On
Shutter Speed	1/30(25) ~ 1/30,000 sec
Iris	0 ~ 20 steps
Digital Slow Shutter(DSS)	Off / x2 / x4 (1/8 : 60 or 50 fps mode only)
Flickerless	Off / On
Brightness	0 ~ 20 steps
WDR/BLC	OFF / WDR / BLC
Day&Night	Auto / Day / Night / Ext-in
White Balance	Auto / One Push / Manual / Indoor / Outdoor
Image	HLC / DNR / Mirror / Sharpness / ACE / Defog / Freeze / Gamma
HLC	Off / On / Night Only
DNR	Auto / Off / Low / Middle / High
Mirror	Off / H / V / H&V
Sharpness	0 ~ 10 steps
ACE	Off / Low / Middle / High
Defog	Off / On (Auto / Manual)
Freeze	Off / On
Gamma	0.45 / 0.55 / 0.65 / 0.75
Intelligence	Privacy / Motion / DIS
Privacy Mask	Off / On (24 points)
Motion Detection	Off / On (3 points)



Digital Image Stabilizer	Off / On
Special Func	Defect / Image Range / System / HD Format / EX-SDI / COMM
Defect DET	Off / On
Image Range	Full / Comp. / User
System	NTSC / PAL
HD Format	1080p/30(25)fps / 1080p/60(50)fps / 720p/30(25)fps / 720p/60(50)fps
EX-SDI	Off / On
HD-TVI	Off / On
Comm	ID : 1 ~ 255
	Baud Rate : 2400 / 4800 / 9600 / 19200 / 38400 / 57600 / 115200
	Protocol : Pelco-P / Pelco-D / VISCA / Update
Display	Disp Sel / Set Title / Init Sel / Set Init Msg / Language
Disp Sel (Off / On)	ID / Title / Zoom Ratio / System Message
Set Title	Text Edit
Init Sel (Off / On)	ID / Baud Rate / Protocol / Version / Init. Message
Set Init Msg	Text Edit
Language	English / Simplified Chinese / Traditional Chinese / Japanese
Power Source	9V to 15V DC
Power Consumption	250mA
Power Input	Connector
Video Output	Connector
Storage Temperature	-20℃ ~ +60℃ (Humidity : 0%RH ~ 90%RH)
Operating Temperature	-10℃ ~ +50℃ (Humidity : 0%RH ~ 90%RH)

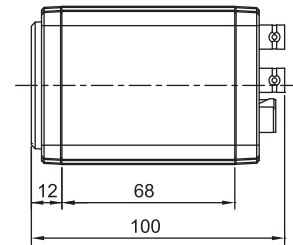
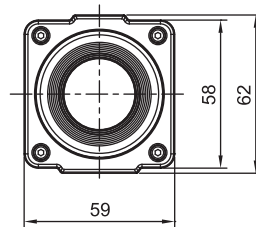
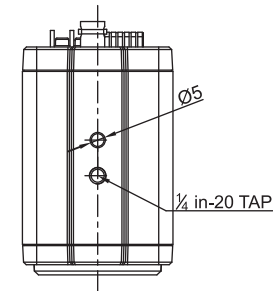

If there are problems in operation, please refer to the items below.  
If the problem persists, please contact the agent you purchased this product from.

Trouble shooting
<ul style="list-style-type: none"><li>• Nothing appears on the screen.</li><li>-Please check the power connection.</li><li>-Please check the video signal line connection.</li></ul>
<ul style="list-style-type: none"><li>• The video image is not clear.</li><li>-Please clean the lens with a clean cloth or brush.</li><li>-Please adjust that the screen is not exposed directly to a bright light.</li><li>-Please move the camera if necessary.</li></ul>
<ul style="list-style-type: none"><li>• The screen is dark.</li><li>-Please adjust the contrast feature of the monitor.</li><li>-If you have an intermediate device, set the 75 Ω /Hi-Z properly, and check the terminals.</li><li>-Please adjust the brightness level.</li></ul>
<ul style="list-style-type: none"><li>• The MOTION DETECTION function is not working</li><li>-Please check if "MOTION DETECTION" mode is turned on.</li><li>-Please check if the MD Sensitivity is too high.</li><li>-Please check the setting of the MD AREA.</li></ul>
<ul style="list-style-type: none"><li>• The WDR function is not working</li><li>-Please check if the WDR Level is too low.</li><li>-Please check if the AE Mode is set to MANUAL. The WDR doesn't work in MANUAL, Shutter priority Exposure mode.</li></ul>
<ul style="list-style-type: none"><li>• Colors are not quite right.</li><li>-Please check if the camera is facing directly into sunlight or fluorescent light.</li></ul>
<ul style="list-style-type: none"><li>• The Day&amp;Night function doesn't work.</li><li>-Please check if the AGC of EXPOSURE menu is set to OFF.</li><li>-The Auto Day&amp;Night doesn't work in AGC OFF status.</li></ul>